

OPERATION DFIG BASED WIND ENERGY CONVERSION SYSTEM WITH AN INTEGRATED ACTIVE FILTER CAPABILITIES USING GRID SIDE CONVERTER (GSC)

GUMMA NAGA RAJU

M.Tech (Power Systems) Department of EEE,
Priyadarshini Institute of Technology and
Management, Pulladigunta, Guntur, A.P.

T. SIREESHA

Assistant Professor, Department of EEE,
Priyadarshini Institute of Technology and
Management, Pulladigunta, Guntur, A.P

ABSTRACT

The main aim of this project is a control strategy for power flow management of a grid-connected hybrid PV-wind-battery based system with an efficient multi-input transformer coupled bidirectional dc-dc converter is presented. The proposed system aims to satisfy the load demand, manage the power flow from different sources, inject surplus power into the grid and charge the battery from grid as and when required. A transformer coupled boost half-bridge converter is used to harness power from wind, while bidirectional buck-boost converter is used to harness power from PV along with battery charging/discharging control. A single-phase full-bridge bidirectional converter is used for feeding ac loads and interaction with grid. The proposed converter architecture has reduced number of power conversion stages with less component count, and reduced losses compared to existing grid-connected hybrid systems. This improves the efficiency and reliability of the system.

using MATLAB/Simulink show the performance of the proposed control strategy for power flow management under various modes of operation.

Key words: PV, DC-DC Converter, Battery, Wind, Hybrid system, MPPT

I. INTRODUCTION

Solar photovoltaic (PV) and wind have emerged as popular energy sources due to their eco-friendly nature and cost effectiveness. However, these sources are intermittent in

nature. Hence, it is a challenge to supply stable and continuous power using these sources. This can be addressed by efficiently integrating with energy storage elements. The interesting complementary behavior of solar insolation and wind velocity pattern coupled with the above mentioned advantages, has led to the research on their integration resulting in the hybrid PV-wind systems. For achieving the integration of multiple renewable sources, the traditional approach involves using dedicated single-input converters one for each source, which are connected to a common dc-bus. However, these converters are not effectively utilized, due to the intermittent nature of the renewable sources. In addition, there are multiple power conversion stages which reduce the efficiency of the system. Significant amount of literature exists on the integration of solar and wind energy as a hybrid energy generation system with focus mainly on its sizing and optimization. In the sizing of generators in a hybrid system is investigated. In this system, the sources and storage are interfaced at the dc-link, through their dedicated converters. Other contributions are made on their modeling aspects and control techniques for a stand-alone hybrid energy system. Dynamic performance of a stand-alone hybrid PV-wind system with battery storage is analyzed. In a passivity/sliding mode control is presented which controls the operation of wind energy system to complement

the solar energy generating system. Not many attempts are made to optimize the circuit configuration of these systems that could reduce the cost and increase the efficiency and reliability. Integrated converters for PV and wind energy systems are presented. PV-wind hybrid system, proposed by Daniel et al., has a simple power topology but it is suitable for stand-alone applications. An integrated four-port topology based on hybrid PV-wind system is proposed. However, despite simple topology the control scheme used is complex. Feed the dc loads, a low capacity multi-port converter for a hybrid system is presented. Hybrid PV-wind based generation of electricity and its interface with the power grid are the important research areas. have proposed a multi-input hybrid PV-wind power generation system which has a buck/buck-boost fused multi-input dc-dc converter and a full-bridge dc- ac inverter. This system is mainly focused on improving the dc-link voltage regulation. In the six-arm converter topology proposed by H. C. Chiang et al. [66], the outputs of a PV array and wind generators are fed to a boost converter to match the dc-bus voltage. The steady-state performance of a grid connected PV is analyzed in [4]. This paper focuses on system engineering, such as energy production, system reliability, unit sizing, and cost analysis. In a hybrid PV-wind system along with

a battery is presented, in which both sources are connected to a common dc-bus through individual power converters. In addition, the dc-bus is connected to the utility grid through an inverter. The use of multi-input converter (MIC) for hybrid power systems is attracting increasing attention because of reduced component count, enhanced power density, compactness and centralized control. Due to these advantages, many topologies are proposed and they can be classified into three groups, non-isolated, fully-isolated and partially-isolated multi-port topologies. All the power ports in non-isolated multi-port topologies share a common ground. To derive the multi-port dc-dc converters, a series or parallel configuration is employed in the input side [63] - [67]. Some components can be shared by each input port. However, a time-sharing control scheme couples each input port, and the flexibility of the energy delivery is limited. The series or parallel configuration can be extended at the output to derive multi-port dc-dc converters [68]. However, the power components cannot be shared. All the topologies in non-isolated multi-port are mostly combinations of basic topology units, such as the buck, the boost, the buck-boost or the bidirectional buck/boost topology unit. These time-sharing based multi-port topologies promise low-cost and easy implementation. However, a common limitation is that power from multiple inputs cannot be transferred simultaneously to the load. Further, matching wide voltage ranges will be difficult in these circuits. This made the researchers to prefer isolated multi-port converters compared to non-isolated multi-port dc- dc converters. The magnetic coupling approach is used to derive a multi port converter [69] - [36], where the multi-winding transformer is employed to combine each terminal. In fully isolated multi- port dc-dc converters, the half-bridge, full-bridge, and hybrid- structure based multi-port dc-dc converters with a magnetic coupling solution

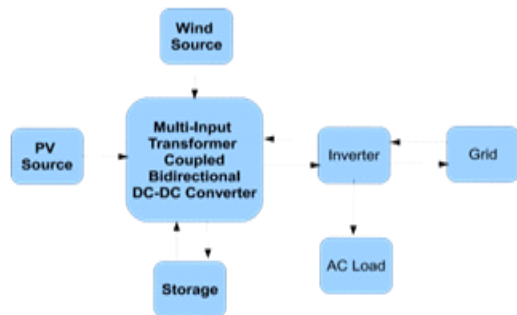

Fig.1. Grid-connected hybrid PV-wind-battery based system for household applications.

can be derived for different applications, power, voltage, and current levels. The snubber capacitors and transformer leakage inductance are employed to achieve soft-switching by adjusting the phase-shift angle. However, the circuit layout is complex and the only sharing component is the multi-winding transformer. So, the disadvantage of time sharing control to couple input port is overcome. In order to address the above limitations, partially isolated multi-port this topology is essentially a modified version of the half-bridge topology with a free-wheeling circuit branch consisting of a diode and a switch across the primary winding of the transformer. The power density is improved and circuit structure is simplified. However, it can interface only one renewable source and energy storage element. Further, the pulse width modulation plus phase-shift control strategy is introduced to provide two control freedoms and achieve the decoupled voltage regulation within a certain operating range. All the state of the art on converter topologies presented so far can accommodate only one renewable source and one energy storage element. The proposed system has two renewable power sources, load, grid and battery. Hence, a power flow management system is essential to balance the power flow among all these sources. The main objectives of this system are as follows:

To explore a multi-objective control scheme for optimal charging of the battery using multiple sources.

Supplying un-interruptible power to loads.

Ensuring evacuation of surplus power from renewable sources to the grid, and charging the battery from grid as and when required.

The grid-connected hybrid PV-wind-battery based system for household applications is shown in Fig. 1, which can work either in stand-alone or grid connected mode. This system is suitable for household applications, where a

low-cost, simple and compact topology capable of autonomous operation is desirable. The core of the proposed system is the multi-input transformer coupled bidirectional dc-dc converter that interconnects various power sources and the storage element. Further, a control scheme for effective power flow management to provide uninterrupted power supply to the loads, while injecting excess power into the grid is proposed. Thus, the proposed configuration and control scheme provide an elegant integration of PV and wind energy source. It has the following advantages:

MPP tracking of both the sources, battery charging control and bidirectional power flow are accomplished with six switches.

II. PROPOSED CONVERTER CONFIGURATION

(1-Dw)

The proposed converter consists of a transformer coupled boost dual-half-bridge bidirectional converter fused with bidirectional buck-boost converter and a single-phase full-bridge inverter. The proposed converter has reduced number of power voltage boosting are accomplished through a single converter. Transformer coupled boost half-bridge converter is used for harnessing power from wind and a single-phase full-bridge bidirectional converter is used for feeding ac loads and interaction with grid. The proposed converter has reduced number of power conversion stages with less component count and high efficiency compared to the existing grid-connected converters. The power flow from wind source is controlled through a unidirectional boost half-bridge converter. For obtaining MPP effectively, smooth variation in source current is required which can be obtained using an inductor. In the proposed topology, an inductor is placed in series with the wind source which ensures continuous current and thus this inductor current can be used for maintaining MPP current. When switch T₃ is ON, the current

flowing through the source inductor increases. The capacitor C1 discharges through the transformer primary and switch T 3 as shown in Fig. 6(b). In secondary side capacitor C3 charges through transformer secondary and anti-parallel diode of switch T 5. When switch T 3 is turned OFF and T 4 is turned ON, initially the inductor current flows through anti- parallel diode of switch T 4 and through the capacitor bank. The path of current is shown in Fig. 6(c). During this interval, the current flowing through diode decreases and that flowing through transformer primary increases. When current flowing through the inductor becomes equal to that flowing through transformer primary, the diode turns OFF. Since, T 4 is gated ON during this time, the capacitor C6 now discharges through switch T 4 and transformer primary. During the ON time of T 4, anti-parallel diode of switch T 6 conducts to charge the capacitor C4. The path of current flow is shown in Fig. 6(d). During the ON time of T 3, the primary voltage $V_P = -VC1$. The secondary voltage $V_S = nV_P = -nVC1 = -VC3$, or $VC3 = nVC1$ and voltage across primary inductor L_w is V_w . When T 3 is turned OFF and T 4 turned ON, the primary voltage $V_P = VC6$. Secondary voltage $V_S = nV_P = nVC6 = VC4$ and voltage across primary inductor L_w is $V_w - (VC1 + VC6)$. conversion stages with less component count and high efficiency compared to the existing grid-connected schemes. The topology is simple and needs only six power switches. The schematic diagram of the converter is depicted in Fig. 6(a). The boost dual-half-bridge converter has two dc-links on both It can be proved that $(VC1 + VC6)$ The capacitor voltages are considered constant in steady state and they settle at $VC3 = nVC1$, $VC4 = nVC6$. Hence the output voltage is given by V_w sides of the high frequency transformer. Controlling the voltage of one of the dc-links, ensures controlling the voltage of the other. This makes the control strategy simple. Moreover, additional converters can be

integrated with any one of the two dc-links. A bidirectional buck-boost dc-dc converter is integrated with the primary side dc-link and single-phase full- bridge bidirectional converter is connected to the dc-link of the secondary side. The input of the half-bridge converter is formed by connecting the PV array in series with the battery, thereby incorporating an inherent boosting stage for the scheme. The boosting capability is further enhanced by a high frequency step-up transformer. The transformer also ensures galvanic isolation to the load from the sources and the battery. Bidirectional buck-boost converter is used to harness power from PV along with battery charging/discharging control. The unique feature of this converter is that MPP tracking, battery charge control and Therefore, the output voltage of the secondary side dc-link is a function of the duty cycle of the primary side converter and turns ratio of transformer.

In the proposed configuration as shown in Fig., a bidirectional buck-boost converter is used for MPP tracking of PV array and battery charging/discharging control. Further, this bidirectional buck-boost converter charges/discharges the capacitor bank C1-C6 of transformer coupled half-bridge boost converter based on the load demand. The half-bridge boost converter extracts energy from the wind source to the capacitor bank C1-C6. During battery charging mode, When switch T 1 is ON, the energy is stored in the inductor

L. When switch T 1 is turned OFF and T 6 is turned ON, energy stored in L is transferred to the battery. If the battery discharging current is more than the PV current, inductor current becomes negative.

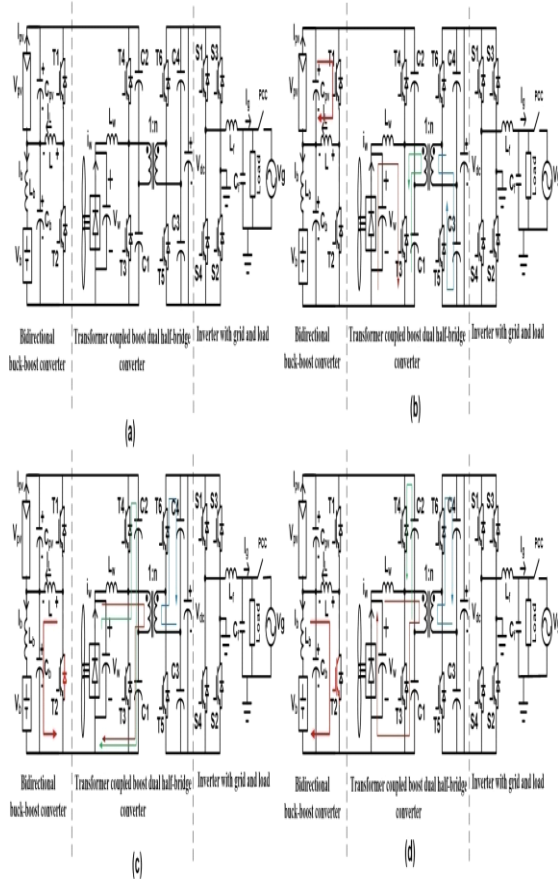

Fig.2. Operating modes of proposed multi-input transformer coupled bidirectional dc-dc converter. (a) Proposed converter configuration. (b) Operation when switch T3 is turned ON. (c) Operation when switch T4 ON, charging the capacitor bank. (d) Operation when switch T4 ON, capacitor C6 discharging.

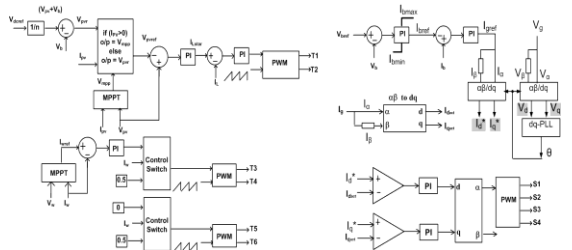

Fig.3. Proposed control scheme for power flow management of a grid-connected hybrid PV wind-battery based system.

Here, the stored energy in the inductor increases when T 6 is turned on and decreases when T 1 is turned on. It can be proved while maintaining proper battery charge level. I_L is used as inner loop control parameter for faster dynamic response while $V_{dc} = n(V_{C1} + V_{C6}) = n(V_b + V_{pv})nV_wD_w$ ensuring MPP voltage. An incremental conductance method is used for MPPT. This voltage is n times of primary side dc-link voltage. The primary side dc-link voltage can be controlled by half-bridge boost converter or by bidirectional buck-boost converter. The relationship between the average value of inductor, PV and battery current over a switching cycle is given by $I_L = I_b + I_{pv}$. It is evident that, I_b and I_{pv} can be controlled by controlling I_L . Therefore, the MPP operation is assured by controlling I_L .

III.SIMULATION RESULTS

EXISTING RESULTS

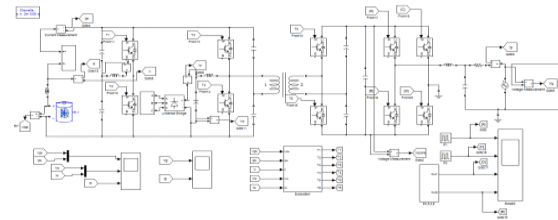

Fig3: SIMULINK Circuit of PV WIND BATTERY Storage Circuit

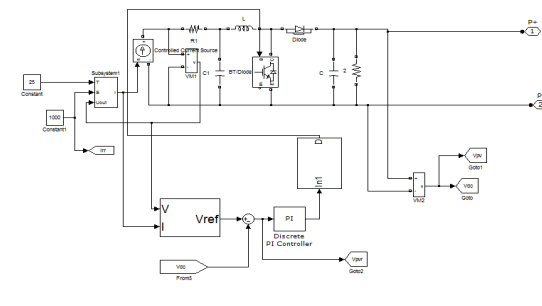

Fig 4: Indicates the SIMULINK PV Systems

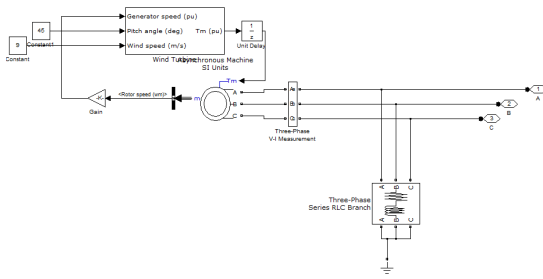

Fig 5: Indicates the simu link of Wind Energy System

Pi controller

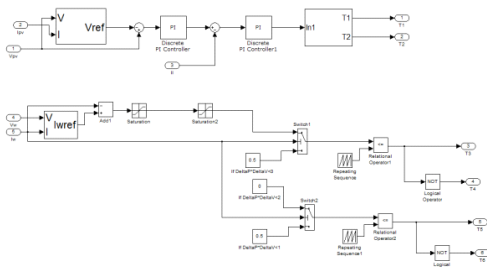

Fig 6. Controller subsystem

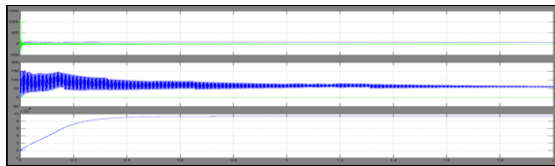

Fig 7. Steady state operation in MPPT mode Vpv, Ipv, Vw, Iw, Ib

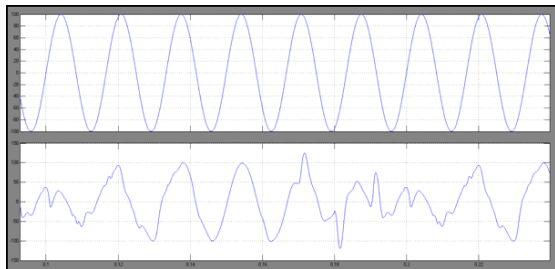

Fig 8. Steady state operation in MPPT mode. Vg and Ig

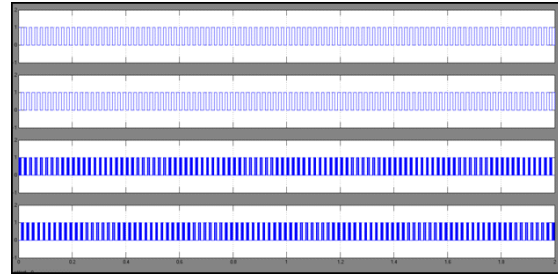

Fig 9. Pulses

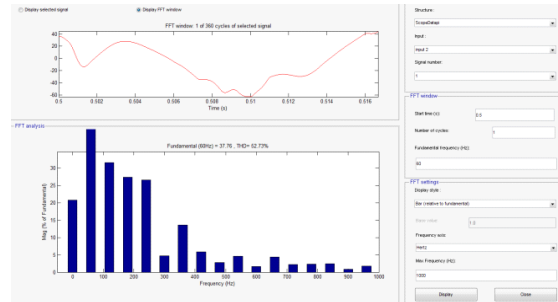

Fig 10 THD % of Ig is 52%(pi controller)

CONCLUSION

A grid-connected hybrid PV-wind-battery based power evacuation scheme for household application is proposed. The proposed hybrid system provides an elegant integration of PV and wind source to extract maximum energy from the two sources. It is realized by a novel multi-input transformer coupled bidirectional dc-dc converter followed by a conventional full-bridge inverter. A versatile control strategy which achieves better utilization of PV, wind power, battery capacities without effecting life of battery and power flow management in a grid-connected hybrid PV-wind-battery based system feeding ac loads is presented. Detailed simulation studies are carried out to ascertain the viability of the scheme. The simulation results obtained are in close agreement with simulations and are supportive in demonstrating the capability of the system to operate either in grid feeding or stand-alone mode. The proposed configuration is capable of supplying uninterrupted power to ac loads, and ensures

evacuation of surplus PV and wind power into the grid. The Simulation results obtained using MATLAB/Simulink

REFERENCES

- [1] F. Valenciaga and P. F. Puleston, "Supervisor control for a stand-alone hybrid generation system using wind and photovoltaic energy," *IEEE Trans. Energy Convers.*, vol. 20, no. 2, pp. 398-405, Jun. 2005.
- [2] C. Liu, K. T. Chau and X. Zhang, "An efficient wind-photovoltaic hybrid generation system using doubly excited permanent-magnet brushless machine," *IEEE Trans. Ind. Electron.*, vol. 57, no. 3, pp. 831-839, Mar. 2010.
- [3] W. Qi, J. Liu, X. Chen, and P. D. Christofides, "Supervisory predictive control of standalone wind/solar energy generation systems," *IEEE Trans. Control Sys. Tech.*, vol. 19, no. 1, pp. 199-207, Jan. 2011.
- [4] F. Giraud and Z. M. Salameh, "Steady-state performance of a gridconnected rooftop hybrid wind-photovoltaic power system with battery Storage," *IEEE Trans. Energy Convers.*, vol. 16, no. 1, pp. 1-7, Mar. 2001.
- [5] S. K. Kim, J. H. Jeon, C. H. Cho, J. B. Ahn, and S. H. Kwon, "Dynamic modeling and control of a grid-connected hybrid generation system with versatile power transfer," *IEEE Trans. Ind. Electron.*, vol. 55, no. 4, pp. 1677-1688, Apr. 2008.